

5000.1012K4M Low Profile DATA SHEET



KIT CONTAINS

UNIDRAIN GLASSLINE UNIT WITH
INTEGRATED GLASS CHANNEL
LOW PROFILE OUTLET
HIGHLINE FRAME
HIGHLINE CASSETTE
GLASS SCREEN

5002.1012 | 5003.1012 Glassline Module

For right-aligned shower screen

For left-aligned shower screen



ITEM NUMBER R

5002.1012

ITEM NUMBER L

5003.1012

Specifications

MATERIAL	SURFACE	FLOORING
1,5 mm stainless steel (AISI 304)	Pickled	Tiles
MEMBRANE	FLOOR CONSTRUCTION	INSTALLATION WIDTH (A)
Liquid or sheet membrane	Concrete/wood	1001 mm
INSTALLATION DEPTH (B)	CENTRE (C)	SHOWER SCREEN SIZE (D)
1301 mm	501 mm	1200 mm

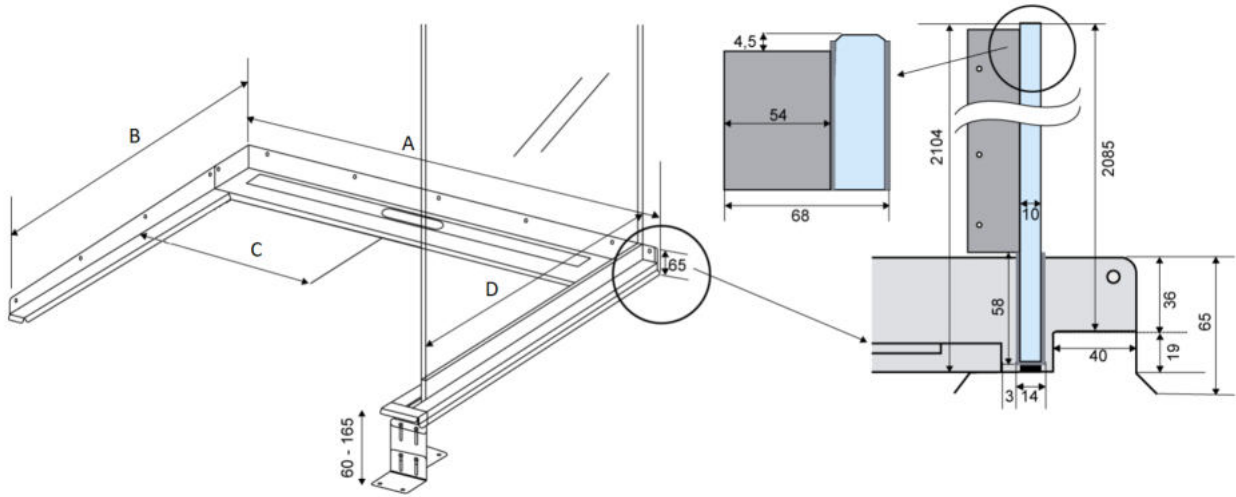

1417.0050 - Low Profile Outlet

Linear 1417.0050

Ø 50 mm horizontal drain

The odour barrier can be removed for cleaning

Can be rotated 180 degrees if a rear-facing outlet is required

Note: Odour barrier is VA-approved



Specifications

ITEM NUMBER	GTIN NUMBER	WEIGHT INCLUDING PACKAGING
1417.0050	5707692007915	500 g
WEIGHT EXCLUDING PACKAGING	MATERIAL	USAGE
350 g	Plastic (PP)	Line drain
BARRIER	GASKET	CAPACITY
With (odour barrier)	EPDM	0.6 l/s
SIDE INLET	CENTER	FITS DRAIN UNIT
Without	30 mm	1001, 1002, 1003, 1004, 1100, 3002, 3004, 5002, 5003, 4004

FITTING HEIGHTS - LINE FAUCETS 1001, 1002, 1003, 1004

Ø	Outlet direction	300	600	700	800	900	1000	1200
Ø 50 mm	Horizontal	64 mm	68 mm	69 mm	70 mm	71 mm	72 mm	74 mm

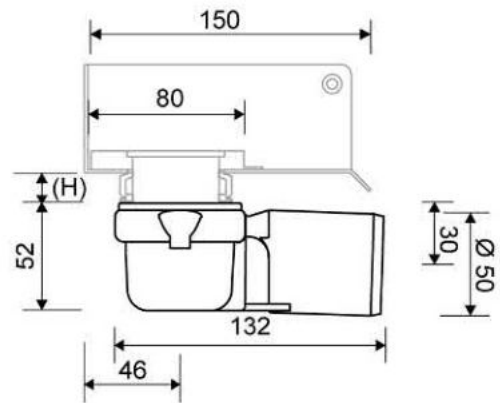
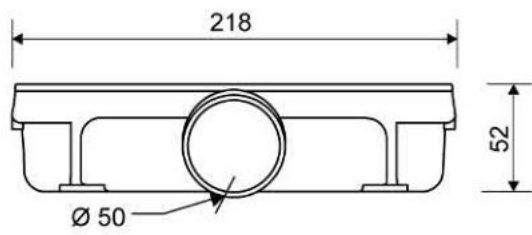
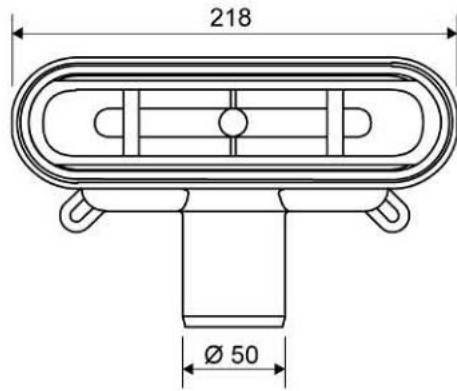

1910.1015 - 1000mm Stainless Steel Frame

Line 1910

Highline Frame can be placed around Highline Custom, Cassette and Panel.
Also available in 10, 12 and 25mm heights (depending on the thickness of the floor tile)
Contact Wetroom Materials for other heights.

Must be installed before tiling.



Specifications

ITEM NUMBER	GTIN NUMBER	WEIGHT INCLUDING PACKAGING
1910.1015	5707692004402	2650 g
WEIGHT EXCLUDING PACKAGING	MATERIAL	USAGE
2530 g	Stainless steel (AISI 304)	Line drain
SURFACE	INSTALLATION LENGTH (L)	HEIGHT (H)
Brushed	995 mm	H 15 mm
LENGTH MODEL	FITS DRAIN UNIT	INSERT
1000 mm	1001, 1002, 1003, 1004, 1100, 5002, 5003	Synthetic

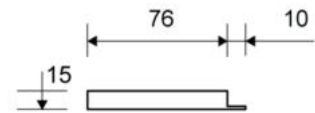
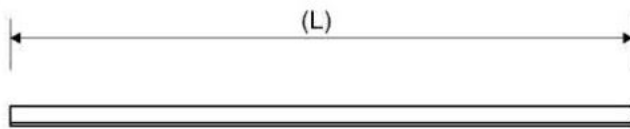
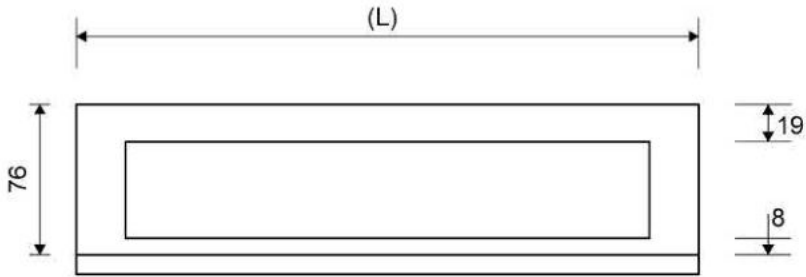

1940.1015 - 1000mm Cassette

HighLine | Cassette

The set consists of a Highline Cassette to place tile into, heightener set and screws.

Can be used with or without Highline Frame.

When using without Highline Frame, ensure rear wall build up allows for equal drainage gap on all sides.

Also available in 10, 12 and 25 mm heights (depending on the thickness of the floor tile).

Contact Wetroom Materials for other heights.



Specifications

ITEM NUMBER	GTIN NUMBER	WEIGHT INCLUDING PACKAGING
1940.1015	5707692005249	1920 g
WEIGHT EXCLUDING PACKAGING	MATERIAL	USAGE
1810 g	Stainless steel (AISI 304)	Line drain
SURFACE	HEIGHT (H)	LENGTH MODEL
Brushed	H 15 mm	1000 mm
HEIGHTENER SET	LENGTH WITH/WITHOUT FRAME	
Plastic (PE)	933/955 mm	

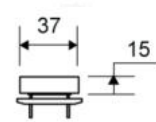
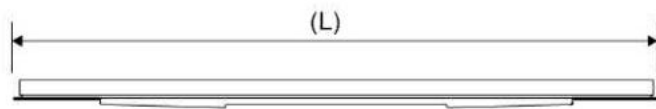
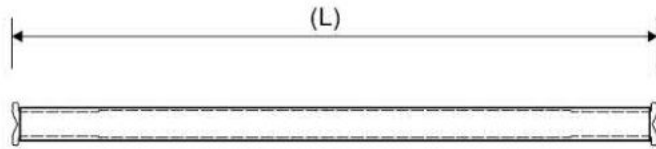

5100.1200

GlassLine | Right and left-aligned shower screen

Design: Transparent

10 mm safety glass

No visible screws or fittings in the finished result

The glass surface is treated with Cleantec nanotechnology, making it water-repellent, less susceptible to limescale and easier to clean.



Specifications

ITEM NUMBER	LENGTH MODEL	HEIGHT (H)
5100.1200	1200 mm	2104 mm
DESIGN	MATERIAL	
Transparent	Stainless steel (AISI 304) 10 mm safety float glass	

